

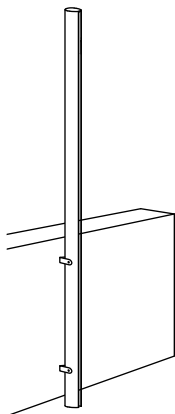

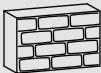



WALL BRACKET INSTALATION

PFFIXWBRAIHD0000

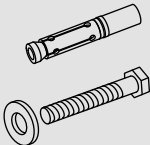
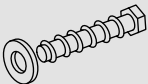

Not included - Niet inbegrepen - Pas inclus
Nicht inbegriffen - No incluido - Non incluso

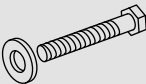
| | | | |
|---|---|---|---|
|  |  |  |  |
|  |  |  |  |
| DIN 9021 DIN 933 M8 | DIN 9021 Ø8 mm | DIN 9021 Ø8 mm | DIN 9021 DIN 933 M8 |

1

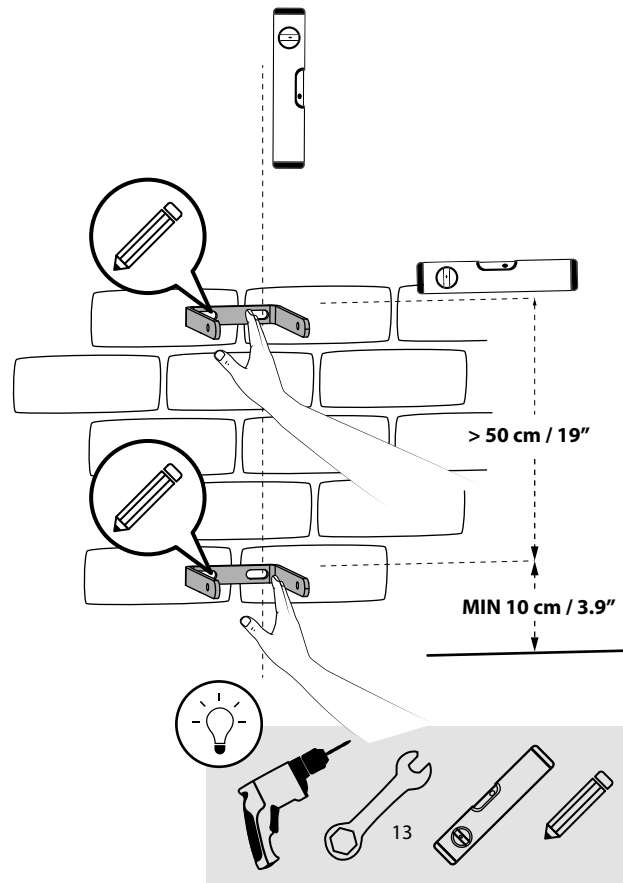

WALL BRACKET INSTALATION



2

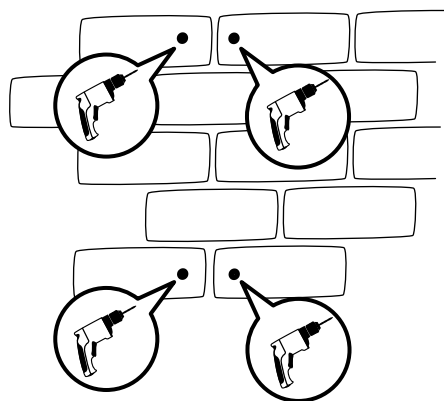

3

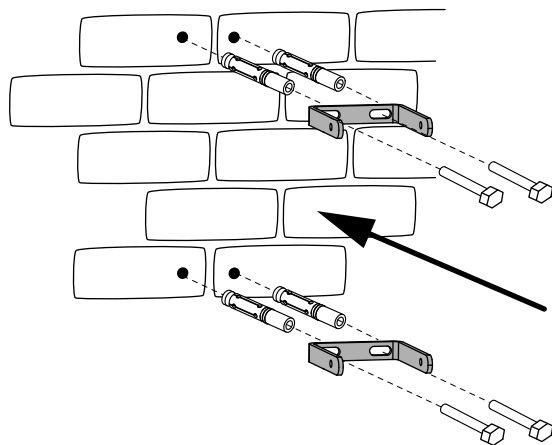

4

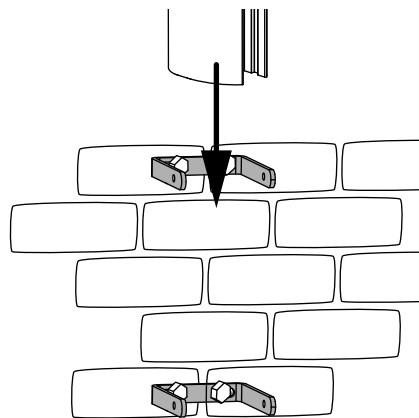

5

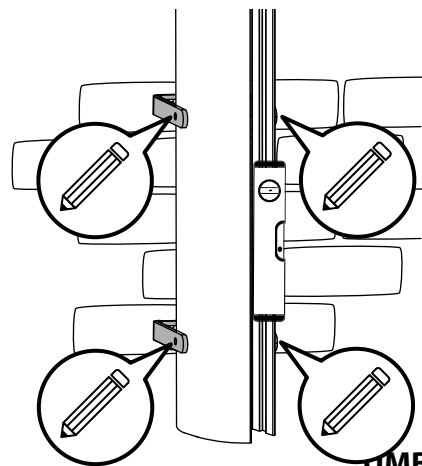

WALL BRACKET INSTALATION



6

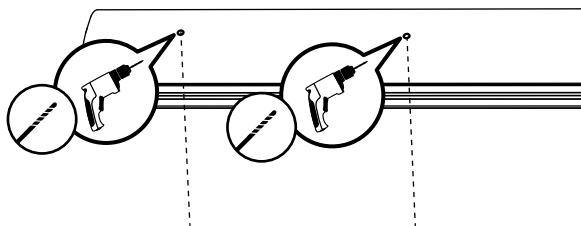

7

